



TREATMENT PERFORMANCE RESULTS

PIA-SR66-1606-1066.02

Cronin Bio Process Ltd.

Johnstown, Kilmichael, Macroom, Co. Cork, Ireland

EN 12566-3

Results corresponding to EN 12566-3 and S.R. 66

Prosafe

Submerged fixed film process in two bioreactors

Nominal organic daily load (influent)	0.28 kg BOD ₅ /d	
Nominal hydraulic daily load	0.90 m ³ /d	
Material	Concrete	
Watertightness	Pass	
Structural behaviour (Crushing resistance)	Pass (also wet conditions)	
Durability	Pass	
Treatment efficiency (nominal sequences)	Efficiency	Effluent
	COD	63 mg/l
	BOD ₅	15 mg/l
	NH ₄ -N	19 mg/l
	SS	14 mg/l
Electrical consumption	1.3 kWh/d	
Number of desludging	Not more than once	

Tested by:

PIA – Prüfinstitut für Abwassertechnik GmbH

(PIA GmbH)

Hergenrather Weg 30

52074 Aachen, Germany

This document replaces neither the declaration of performance nor the CE marking.



April 2024



Notified Body
No.: 1739



Certified according to
ISO 9001:2015

Prosafe range and its referring test reports:

Population equivalent (PE)	Drawing of model of the range	Watertightness (EN 12566-3 Annex A)	Treatment Efficiency (EN 12566-3 Annex B)	Structural Behaviour (EN 12566-3 Annex C)	Durability
Initial Type Test (ITT) 6		Pass PIA2015-WD-1507-1036.01	Pass PIA2016-258B06	Pass PIA2015-ST-BT-1507-1036.01 For wet ground conditions, 0.95 m installation depth from inlet invert	Pass PIA2017-DH-1507-1036.01
12		Pass PIA2015-WD-1507-1036.01	Pass Range conformity according to S.R.66	Pass PIA2015-ST-BT-1507-1036.01 For wet ground conditions, 0.95 m installation depth from inlet invert	Pass PIA2017-DH-1507-1036.01

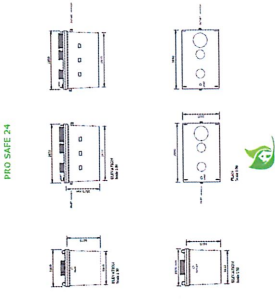
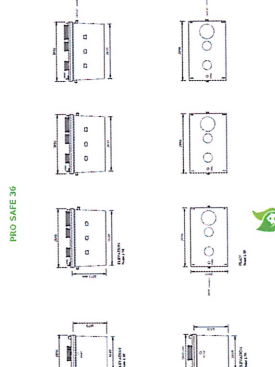
<p>24</p>		<p>Pass</p> <p>PIA2015-WD-1507-1036.01</p>	<p>Pass</p> <p>Range conformity according to S.R.66</p>	<p>Pass</p> <p>PIA2015-ST-BT-1507-1036.01</p> <p>For wet ground conditions, 0.95 m installation depth from inlet invert</p>	<p>Pass</p> <p>PIA2017-DH-1507-1036.01</p>
<p>36</p>		<p>Pass</p> <p>PIA2015-WD-1507-1036.01</p>	<p>Pass</p> <p>Range conformity according to S.R.66</p>	<p>Pass</p> <p>PIA2015-ST-BT-1507-1036.01</p> <p>For wet ground conditions, 0.95 m installation depth from inlet invert</p>	<p>Pass</p> <p>PIA2017-DH-1507-1036.01</p>

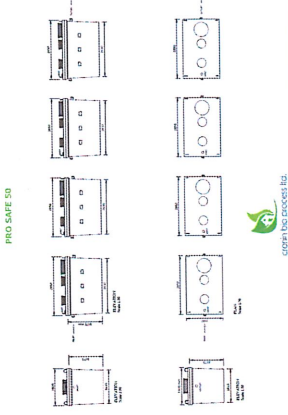
<p>50</p>		<p>Pass</p> <p>PIA2015-WD-1507-1036.01</p>	<p>Pass</p> <p>Range conformity according to S.R.66</p>	<p>Pass</p> <p>PIA2015-ST-BT-1507-1036.01</p> <p>For wet ground conditions, 0.95 m installation depth from inlet invert</p>	<p>Pass</p> <p>PIA2017-DH-1507-1036.01</p>
-----------	---	--	---	---	--

PRO SAFE 6

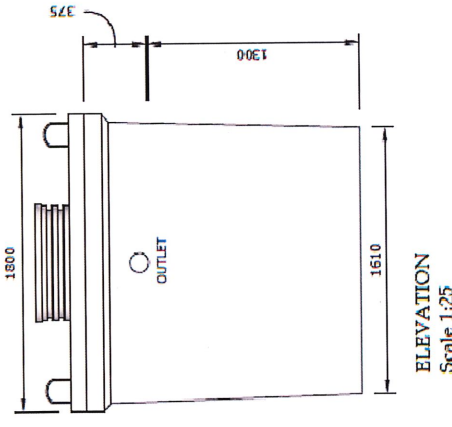
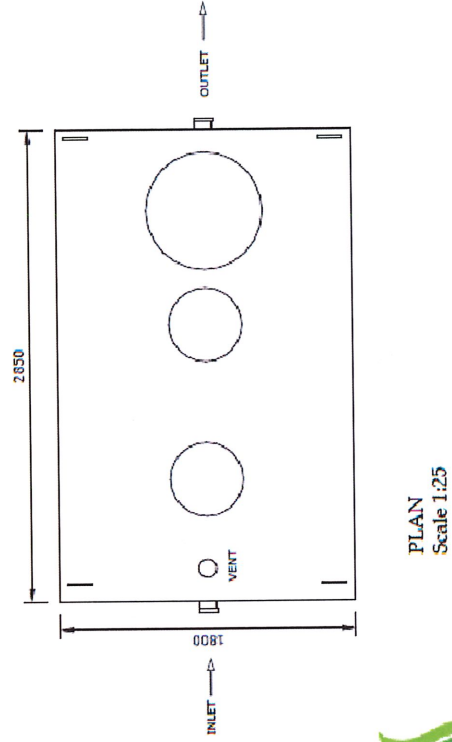
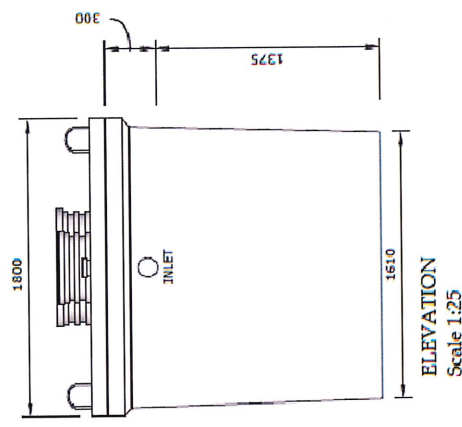
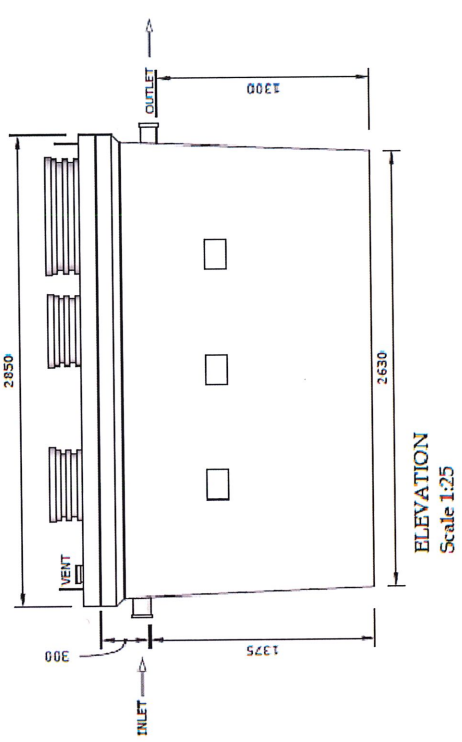

cronin bio process ltd.



PRO SAFE 12

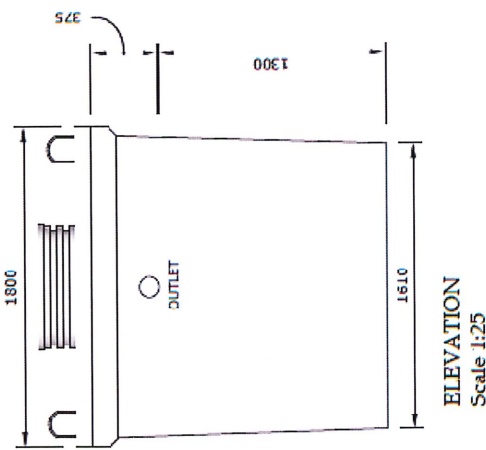
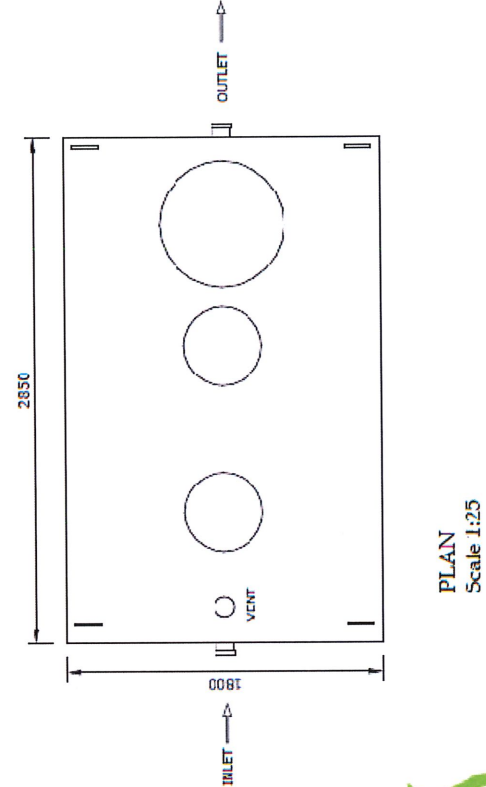
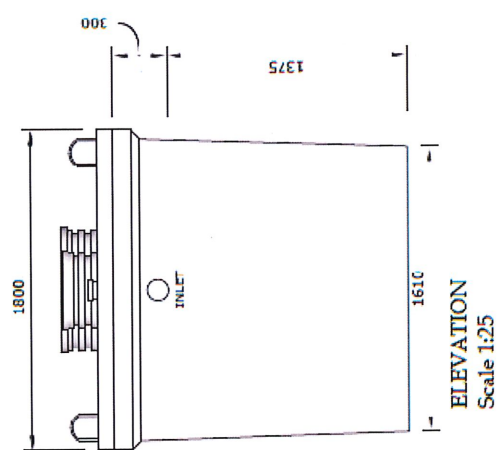
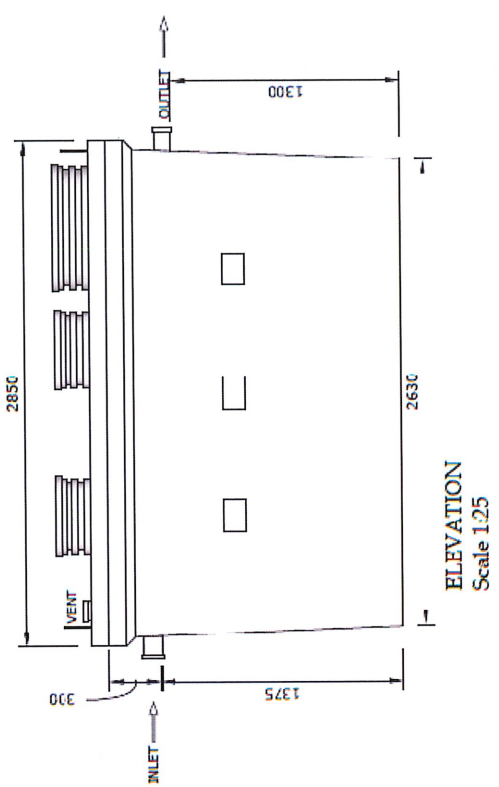

cranin bio process ltd.



PRO SAFE 24

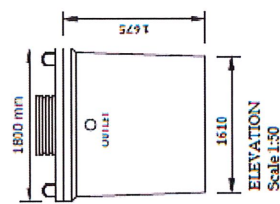
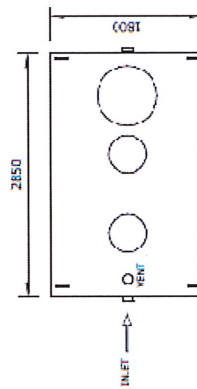
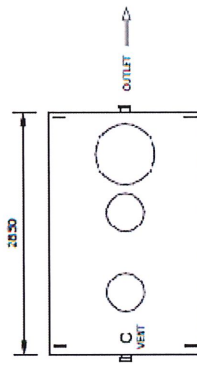
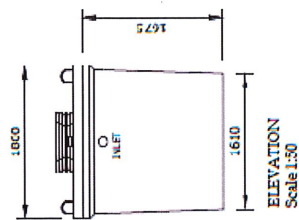
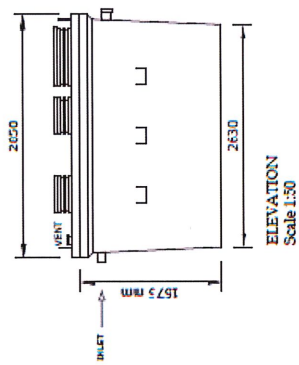
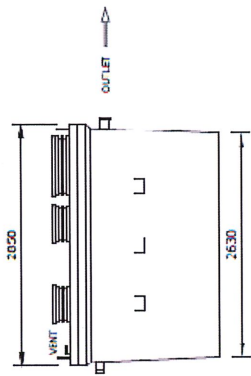

PLAN
Scale 1:50



cronin bio process ltd.



PRO SAFE 36

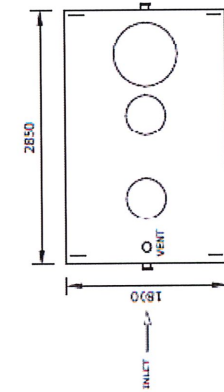
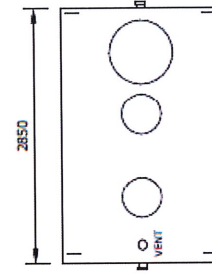
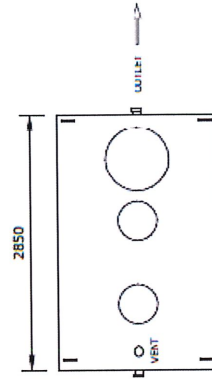
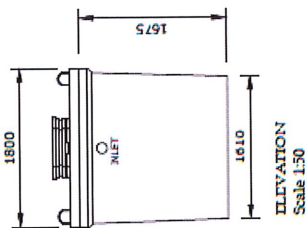
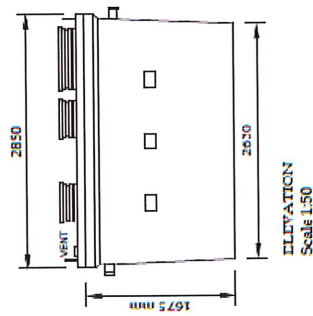
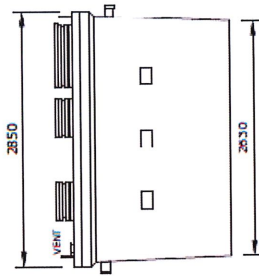
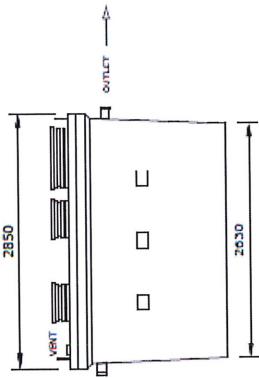

PLAN
Scale 1:50

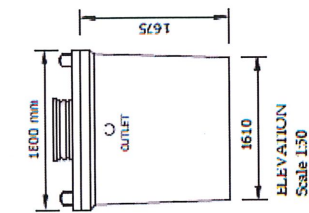

PRO SAFE 50

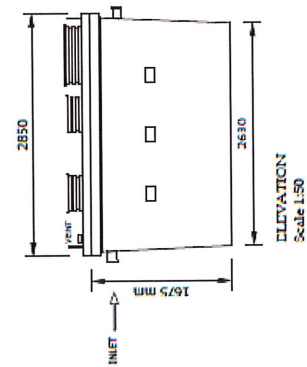
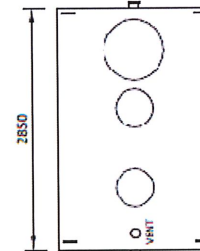
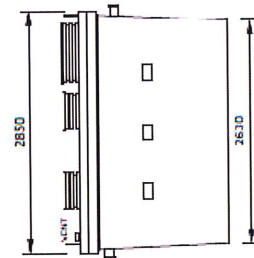
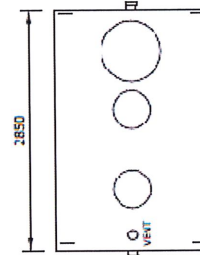
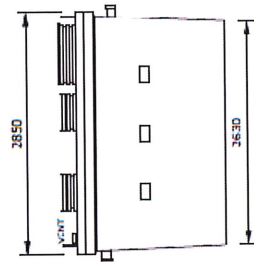
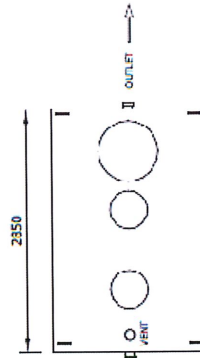
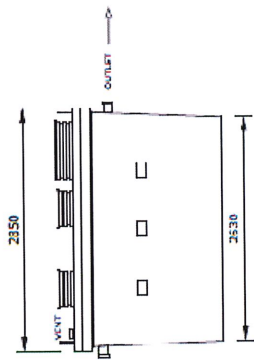

ELEVATION
Scale 1:50

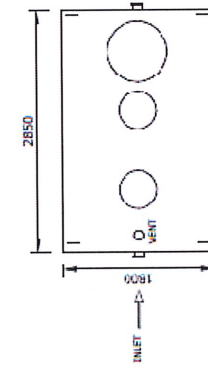

PLAN
Scale 1:50

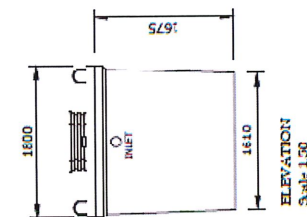

ELEVATION
Scale 1:50

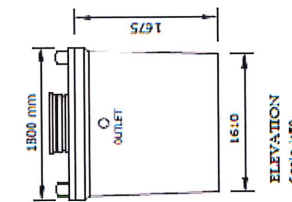

ELEVATION
Scale 1:50



cronin bio process ltd.

